



*The Pavilions
at
Park Green*

Lot 28





Index

1. Park Green
2. Proudly Kiwi
3. Why build with Generation Homes
4. Quote for base home and landscape
5. Standard home features
6. House Plan
7. Base cost component options
 - Kitchen finish - tapware sinks cabinet finishes stone bench tops
 - Appliance packages
 - Bathroom finish - tapware bath basin etc
 - Flooring – tile and carpet
 - Wardrobe plan
 - Electrical plan
8. Outside base quote - Components Generation homes can source, have installed and warranted ready when you move in
 - Wardrobe fit outs
 - Blinds and internal shutters
 - Smart tech
 - Car chargers



Park Green

Park Green, when completed, will rank as one of the most outstanding 21st century places to live in Auckland. Through landscaping and built form, including architectural and aesthetic considerations, technology and transport options, it will offer its residents an environment to complement their lifestyle.

Park Green will cater for recreational interests, provide educational facilities, and a Campus that may include restaurants, cafes, boutique shopping as well as broader retail and commercial businesses within a leafy precinct that will deliver a genuine village atmosphere.

As its name suggests, Park Green will be recognized for the origins of its master developer Hugh Green Group, and for the parklands and green ways that will bring natural life to the streetscape.

Located in the fast-growing South Auckland region, on the shores of the Hingaia Peninsula – the southern coastline of the Manukau Harbour – Park Green is the first offering in Hugh Green Group’s master plan to supply 10,000 homes across Auckland in partnership, which will include schools, local retail and business facilities amongst others.

PARK GREEN WILL PROVIDE

- Circa 1250 dwellings
- New Primary school (planned to open 2022)
- Neighbour hood Campus (planned to open 2023)
- Pedestrian and cycle networks
- Esplanade reserves and stream and wetland areas

THE DEVELOPMENT ROLE OF HUGH GREEN GROUP AT PARK GREEN

- Create an attractive residential community
- Over-arching stewardship
- Quality oversight
- Development controls/design guidelines
- Investment in the public realm

- [Park Green Master Plan Development](#)



Proudly Kiwi

We're a proud Kiwi company that was established in Tauranga more than 20 years ago. We built our foundation on trust and results. Founders David Mansel and Graham Hockly, who both started in the building trade in Tauranga, now head one of the country's leading residential construction companies.



Both David and Graham remain strong in the belief that building doesn't need to be a stressful, time-consuming and cost spiralling exercise. Their aim has always been to provide certainty in the uncertain world of building, and that means creating and implementing simple, streamlined processes and refining them over the years.

With nine branches throughout New Zealand, our point of difference is delivering fixed price homes with a guaranteed move in date. People who build with Generation Homes enjoy the budget security of a fixed price

contract – including all fees needed to get the build underway, and every cost thereafter – right down to the number on the letterbox. There are no hidden costs.

With extensive experience in residential building and development, Generation Homes has established a reputation for reliability, quality and exceptional customer service. Over 5,500 homes have been built by Generation Homes across New Zealand.

Building a community for every generation is at the heart of our business.





Why Generation?

Making building easy for 24 years.

Over the past 21 years we have built nearly 5,500 new homes. 100% were delivered for the price we promised and 97% were delivered on the day we promised.

So when you buy a house and land package from Generation Homes you'll have peace of mind knowing that there will be no unexpected or hidden costs and you can get on with planning your move confident that your house will be ready on time.



PROVEN DELIVERY

- We are one of New Zealand's largest and most successful residential building companies.
- Established in 1997, we've been building homes for close to 25 years.
- To date we've built over 5,500 homes.

SPOILT FOR CHOICE

- Choose from a range of 200 architecturally designed plans.
- We offer expert design advice from our sales team, or select from our professional colour consultant design boards!
- Looking at our smaller offer? We have specifically designed custom plans in our smaller subdivisions to maximise forwards and backwards viewing windows. Just because a site is narrow doesn't mean you should be looking at your neighbours and through smart design we make the most of the your space.

FIXED PRICE GUARANTEE

- The contract price is the price you pay. Once you have chosen your plan and variations, we offer a fixed price that doesn't change.
- Of the 5,500 homes we have built to date, 100% were built for the price we promised.



Making building easy for 24 years

QUALITY ASSURED

- To date we've won 8 Master Builder quality awards.
- Our national supplier and contractor agreements guarantee quality delivery, ensuring the quality of our builds are consistent from one home to the next.
- All our homes are backed by a 10 year Master Builder Guarantee and a 12 month warranty on all building works.
- Generation Homes has a strong commitment to work closely with our suppliers/ contractors and always pay them on time.
- This means we work with the best in the industry to provide you with the assurance that your build is in good hands.

LOCAL EXPERTISE, NATIONAL CLOUT

- We're not a franchise, we're 100% owned by Generation Group Limited.
- So, if something were to go wrong, you'll have the backing of an established national organisation. We have never failed to complete a house.

WE'RE GOOD COMMUNICATORS

- We listen and help you choose the right home for you and your family.
- We are passionate about building and take pride in what we can do in conjunction with you.

WE HAVE BEEN IN YOUR SHOES

- Our team in the Auckland South area have experience buying, building or even starting out on the property ladder in the recent market climate.
- Some of our team even joined after building with Generation Homes. We understand what its like to be on the client end.
- For first home buyers, we understand the Home Start Grant and Kiwi saver withdrawal process and can work with you to help ensure all the timelines match up to help make the process as smooth as possible.
- We have some great industry contacts & can help point you in the right direction.

STANDARD FEATURES

INCLUDED IN YOUR HOME

	ITEM	DESCRIPTION	MAKE	MODEL
Preliminary and General	Builders Guarantee	Residential 10 Year Standard Cover		
	Full Working Drawings	Ready to lodge with Council		
	Engineering Design	Site Specific Foundation Design		
	Building Consent	Issued by Territorial Authority		
	Inspections and CCC	Issued by Territorial Authority		
	Insurance	Construction and public liability		
	Defects service period	12 months		
Site Works and Floor	Site Preparation	Up to 300mm topsoil site scrape to building platform only. Finished with GAP7 aggregate		
	Foundations	Site specific engineered designed Raft Concrete Floor		
	Sewer and Stormwater	Connected to existing onsite connections		
Construction	Framing Interior	H1.2 treated timber		
	Framing Exterior	H1.2 treated timber, H3.2 bottom plate		
	Roof Covering	Long-run	Colorsteel	
	On Site Safety	Scaffold, Edge Protection and safety nets		
	Fascia/Spouting	Colorcote	Continuous	125 OG internal Brackets
	Downpipes	Colorcote	Continuous	80mm DIA.
	Ceiling height	2.55m high flat Ceiling downstairs, 2,40m high flat upstairs		Classic Flat Face
	External Joinery & Windows	Powder Coated Aluminium window and door system with propriety hardware. Double glazed units.	Fairview	Mistlite
	Obscure Glass	WC, bathroom, ensuite and front entry door sidelight (if applicable).	Fairview	PTF
	Window Reveals	Pre-primed 18mm pine		
	Entry Door	Powder coated T&G with Boston Gripset hardware	Fabtech	
	Insulation	Exterior walls, Ceiling , Pink Batts		
	Soffits	Painted	James Hardie	

*Features are subject to change, providing the goods used are of equal or better quality as those listed here.

STANDARD FEATURES

INCLUDED IN YOUR HOME

	ITEM	DESCRIPTION	MAKE	MODEL	
Interior	Walls	10mm Plaster board stopped to level 4 paint finish	GIB Board		
	Ceilings	13mm Plaster board stopped to level 4 paint finish	GIB Board		
	Bathrooms	Aqua Line (Water resistant)	GIB Board		
	Interior Doors	TBA			
	Interior Door Hardware	Interior door lever handles Entrance lock to garage Passage hardware to bedrooms Privacy locks to bathrooms Flush pull handles to sliding wardrobes (if applicable) Dummy hardware with magnetic catches to cupboards			
	Architraves	Windows and doors Claymark M76 90mm paint finish		Finger joined pine	
	Skirtings	Claymark M77 130mm Paint Finished – to carpeted areas only (tiles – none)		Finger joined pine	
	Scotia	None, square stopped			
	Slimlines	Square stop external corners			
	Paint	All finished 3 coats (1 colour to walls and lighter shade to ceilings) level 4 to all surfaces	Resene		
	Cupboard fit outs	Ventilated wire system as per plan	Designer Homeware		
	Cleaning	Professional builders clean on completion & rubbish removed			
	Kitchen	Custom Built Kitchen	Design as per kitchen plan		
		Cabinets	Meltecca	As per builders range	
Doors		As per kitchen plan			
Bench Tops		20mm engineered stone	Smartstone or Silestone (builders range)		
Sink		As per kitchen plan			
Sink Mixer		Englefield Studio Pin	Englefield	97532A	

STANDARD FEATURES

INCLUDED IN YOUR HOME

	ITEM	DESCRIPTION	MAKE	MODEL
Appliances	Ovens	Wall Oven	Westinghouse	WVE615SCA
	Hob	Electric Ceramic 4 zone cooktop	Westinghouse	WHC643BC
	Rangehood	Undermount	Ariston	ARU52AX-L
	Dishwasher	Freestanding	Westinghouse	WSF6608XA
	Insinkerator	Food Waste Disposer	Insinkerator	MODEL66
	Heatpump	Hi-Wall	Panasonic	RZ60SKR
	Plumbing	All polyethelene pipe work	Hot & Cold Water	
2x Outdoor Taps				
Hot Water Cylinder		Mains pressure 180L	Rheem	
Laundry		Custom Laundry as per plan laminate benchtop	As per builders range	
Laundry Mixer		Studio Pin Basin Mixer	Englefield	97531-A-4
Bathroom/ Ensuite	Shower	Tiled showers as per plans		
	Shower Door	Toughened Glass Door		
	Shower Mixer	Studio Pin Level	Englefield	975334-4
	Shower Head	Studio Pin Slider Shower	Englefield	29689A
	Basin Mixer	Studio Pin	Englefield	97531A-4
	Bath	Vetralla Quarrycast Freestanding Bath 1500 x 731 x 548	Robertson	52094.10
	Bath Mixer & Spout	Studio Pin Lever Wall Mount	Englefield	20149A-4
	Vanity	Boston Wall hung Vanity White 1DR as per plan	Raymor	
	Mirror	TBA		
	Heated Towel Rail	Square Heated Towel Rail 7 Bar	Adesso	697176
	Toilet	Form back to wall toilet suite	Adesso	729193
	Inline Extraction Fan	361m3/h with timer	Fantech	LK150NTP

*Features are subject to change, providing the goods used are of equal or better quality as those listed here.

STANDARD FEATURES

INCLUDED IN YOUR HOME

	ITEM	DESCRIPTION	MAKE	MODEL
Electrical	Temporary Power	Builders temporary supply during construction		
	Light Outlets	In ceiling recessed LED downlights as per electrical plan		
	Two Way Light Circuits	As per electrical plan		
	Power Points	As per electrical plan	PDL	S600
	Television Outlets	As per electrical plan		
	Television Aerial	UHF		
	Telephone Outlets	As per electrical plan		
	Security	Wiring only for alarm		
	Smoke Alarms	Included		
	Pre-wire for electric vehicle charger	Included		
Tiling and Flooring	Wall Tiles	Full Height in bathroom, ensuite & laundry		
	Floor Tiles	As per builders range	Client selection	
	Floor Tiles	Entry, Kitchen, bathroom, ensuite and laundry		
	Carpet	100% premium 46oz soft solution dyed nylon to non-tile areas	Belgotex	Federal
		OR		
		100% premium 46oz solution dyed nylon to non-tile areas	Malmo	Munich
	Underlay	10mm	Vitality Home	
Landscaping	Driveway, Terraces &	As per landscaping plan		
	Paths Fencing	As per landscaping plan		
	Clothesline	Fold-out option		
	Lawn	As per landscaping plan		
	Planting	As per landscaping plan		
	Letterbox	As per landscaping plan		

*Features are subject to change, providing the goods used are of equal or better quality as those listed here.

CONCEPT

NOTES
DO NOT SCALE OFF DRAWINGS
CONTRACTOR TO VERIFY ALL
DIMENSIONS ON SITE
CONTRACTOR TO LOCATE AND
PROTECT EXISTING SERVICES ON SITE
PRIOR TO COMMENCING ANY
CONSTRUCTION WORKS.

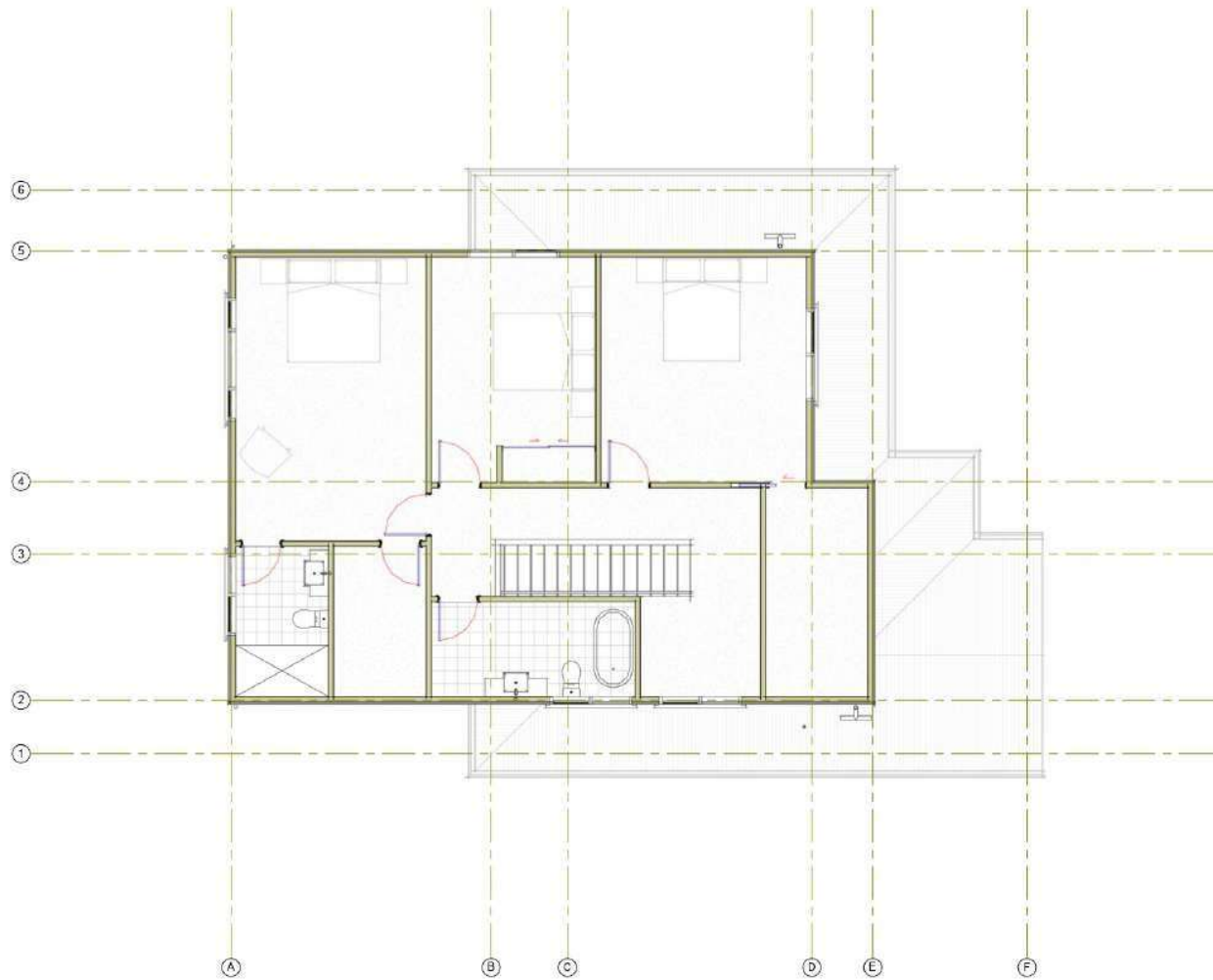

GROSS FLOOR AREA = 106m²

CONCEPT

NOTES
DO NOT SCALE OFF DRAWINGS
CONTRACTOR TO VERIFY ALL
DIMENSIONS ON SITE
CONTRACTOR TO LOCATE AND
PROTECT EXISTING SERVICES ON SITE
PRIOR TO COMMENCING ANY
CONSTRUCTION WORKS.

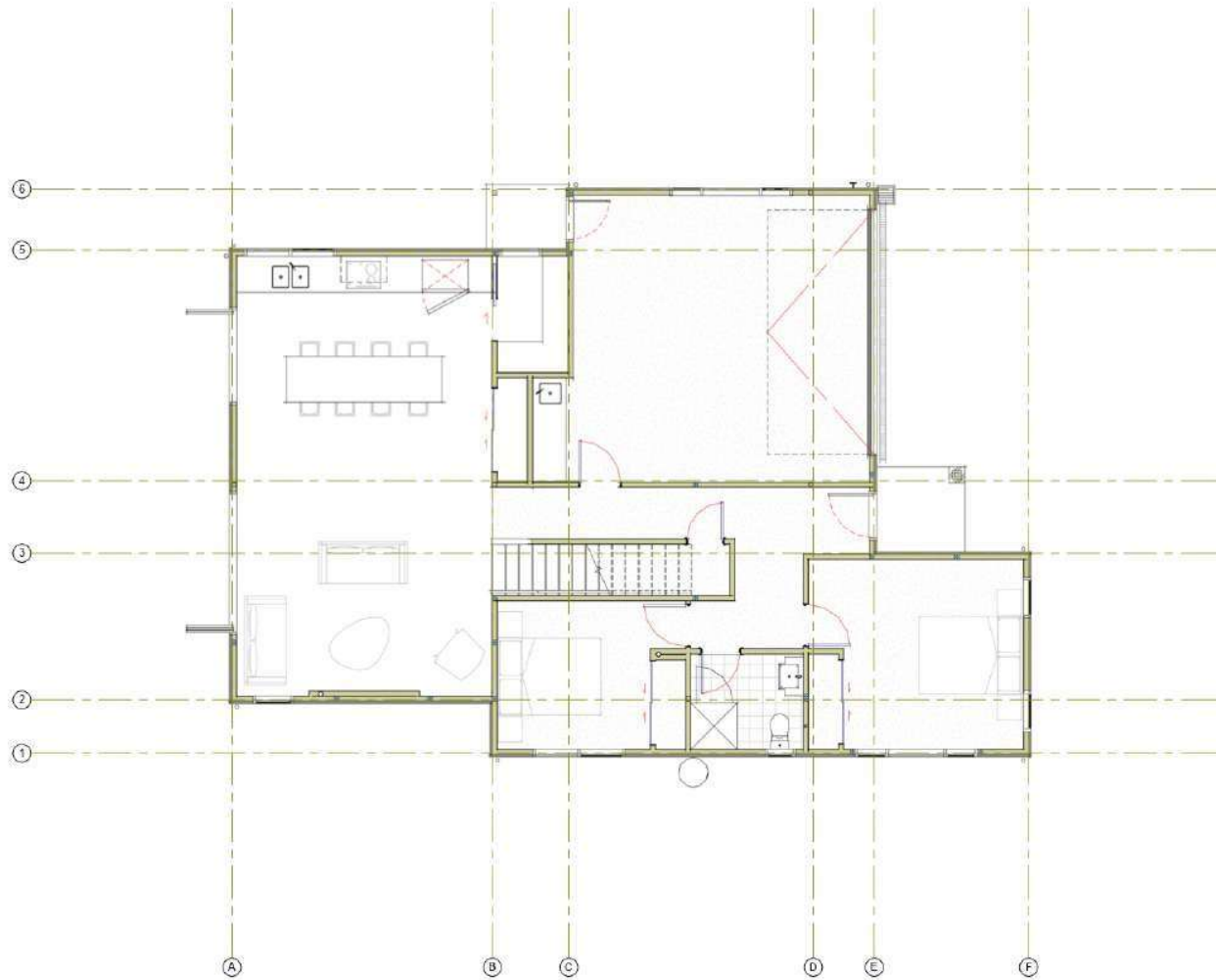

GROSS FLOOR AREA = 139m²

NAUTICAL RANGE BASE OPTIONS

APPLIANCES

Your Generation appliance package comes with a 5 Year Warranty

5 Year warranty covers the Oven, Cooktop, and dishwasher - Refrigeration are covered for 2 years.

Colour Disclaimer: Please note colours may vary, it is recommended to go view the colours prior to making a decision.

Harvey Norman
COMMERCIAL DIVISION



Stainless Steel Appliance Pack



Westinghouse 5 Function Stainless steel

Inbuilt Oven. Model : WVE615SCA



Ariston 52cm Undermount Rangehood

Model : ARU52AX-L

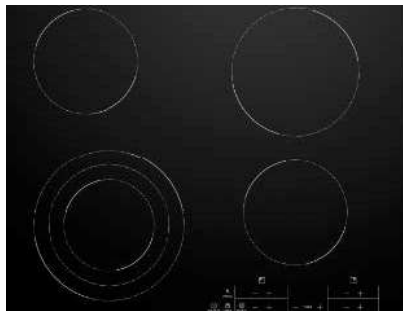

Westinghouse 4 Zone Ceramic cooktop

Model : WHC643BC



Westinghouse 13 Place Stainless Steel Dishwasher

Model : WSF6608XA



Dark Stainless Steel Appliance Pack



Westinghouse 5 Function Dark Stainless steel

Inbuilt Oven. Model : WVE615DSCA



Ariston 52cm Undermount Rangehood

Model : ARU52AX-L

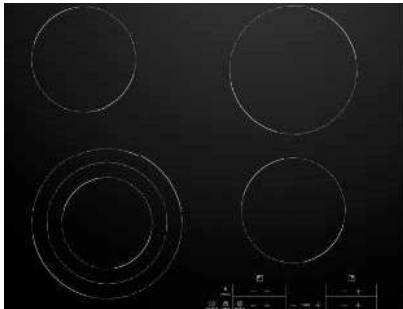

Westinghouse 4 Zone Ceramic cooktop

Model : WHC643BC



Westinghouse 13 Place Dark Stainless Steel Dishwasher

Model : WSF6608KXA



White Appliance Pack



Westinghouse 5 Function White

Inbuilt Oven. Model : WVE615WC



Ariston 52cm Undermount Rangehood

Model : ARU52AX-L

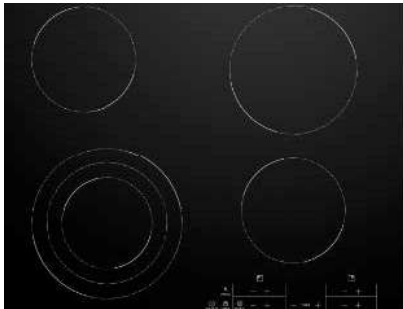

Westinghouse 4 Zone Ceramic cooktop

Model : WHC643BC



Westinghouse 13 Place White Dishwasher

Model : WSF6608WA



NAUTICAL RANGE BASE OPTIONS

BATHROOMWARE



Colour Disclaimer: Please note colours may vary, it is recommended to go view the colours prior to making a decision.

mico design



TAPWARE

Studio Pin Level Basin Mixer



Chrome

Tap Height: 141mm

Spout Reach: 101mm

Suitable for mains pressure.

5 Star WELS, 6L/min

Warranty



Black

Tap Height: 141mm

Spout Reach: 101mm

Suitable for mains pressure.

5 Star WELS, 6L/min

Warranty



Brush Nickel

Tap Height: 141mm

Spout Reach: 101mm

Suitable for mains pressure.

5 Star WELS, 6L/min

Warranty

Fittings & Fixtures



Vetralla Freestanding Bath 1500 Quarrycast

Model : 52094.10



Boston Wall Hung Vanity

Model : Raymor



Adesso Form Back to Wall Toilet Suite



Studio Pin basin mixer

Model : 20149A-4-CP



Studio Pin Slide Shower

Model : 29689A-CP



Adesso Square Heated Towel Rail 7 Bar Wide

Model : 697176

NAUTICAL RANGE BASE OPTIONS

TILES



Colour Disclaimer: Please note colours may vary, it is recommended to go view the colours prior to making a decision.

Price Disclaimer: Please note certain designs and personal consultations fall outside of the contractual price, these will be raised as soon as possible.

the **tile depot**



TILES

Walls – Genesis Range



Desert White Matt 450x120

Desert is a reminder of fluidity and continuous movement.

Genesis: at the cutting-edge of design. This versatile collection takes us back to the roots where everything began. An awakening of senses with textural elements, as a starting point heading to elegance and style. Smooth matt white allows to build minimalistic settings and combine with bold decoration.



Palm White Matt 450x120

Palm and Leaf nature patterns are visible and clear.

Genesis: at the cutting-edge of design. This versatile collection takes us back to the roots where everything began. An awakening of senses with textural elements, as a starting point heading to elegance and style. Smooth matt white allows to build minimalistic settings and combine with bold decoration.



TILES

Floor – Ego Collection



Ego Avorio 300x600

The Ego collection, inspired by an ancient Mexican stone, tempered by the passing of time, features a surface that enhances its blend of granite and limestone. The collection is completed by the Trame decor, which, combined with the plain tiles, increases the number of design possibilities.

(THESES SIZES ARE INDENT PNLY)

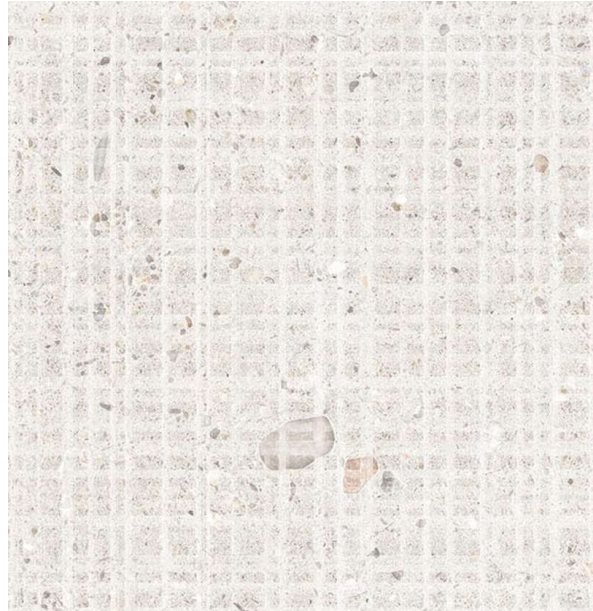

Ego TRAME AVORIO 300x600

The Ego collection, inspired by an ancient Mexican stone, tempered by the passing of time, features a surface that enhances its blend of granite and limestone. The collection is completed by the Trame decor, which, combined with the plain tiles, increases the number of design possibilities.

(THESES SIZES ARE INDENT PNLY)



TILES

Base Scheme 1



TERRAMIX WHITE 600 X 600

Terramix is a contemporary cement-effect porcelain with a gentle scattering of mixed sized aggregate. The collection has a lovely matt honed appearance and is available in five modern colourways. Rectified with an R10 finish, Terramix is a family Friendly tile for residential interiors on both floors and walls. Available in five colours.

[View Online >](#)



TOUCH 75x300

The Touch series is a collection of glazed ceramic wall tiles with a wavy edge and distinctly hand-made appearance. Available in a range of Colours.

[View Online >](#)



TILES

Base Scheme 2



STONE VALLEY LIGHT 600X600

Stone valley range combines the beauty of travertine, with the durability of glazed porcelain.

The stone has been reproduced in its natural colours, preserving the design and surface to be

Able to bring it into our homes in all its purity.

Suitable for interior floors and wall. Available

In four colours and has a matching

Antislip tile also available.

[View Online >](#)



CASABLANCA 58X242

Casablanca gloss collection is a stunning wall tile range. Available in nine vibrant bright colours.

Each colour comes with a shade variation containing

3 light, 3 mid and 3 dark shades. Fantastic range for

Kitchen splashbacks and feature walls in bathrooms.

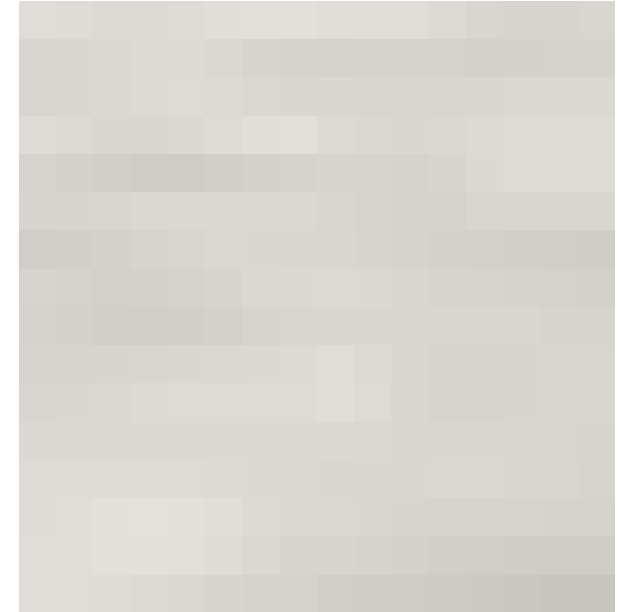

AMBER WHITE 200 X 1200

The Amber range is an incredibly realistic porcelain replica of timber planks. Amber recreates the textures, knots and grains found in real wood whilst offering all the modern benefits of a stain, water and wear resistant floor. Suitable for interior floors and walls, Amber is available in 200x1200mm, in 5 stocked colours

[View Online >](#)

TILES

Base Scheme 3



ENZO COAL 600X600

The Enzo range has MICROGRIP technology, delivering a very smooth feel on the surface - a perfect choice for bathroom, kitchen and laundry. It achieves an unbelievably high anti-slip rating in wet conditions, making it suitable for outdoor areas such as pool or Balcony.

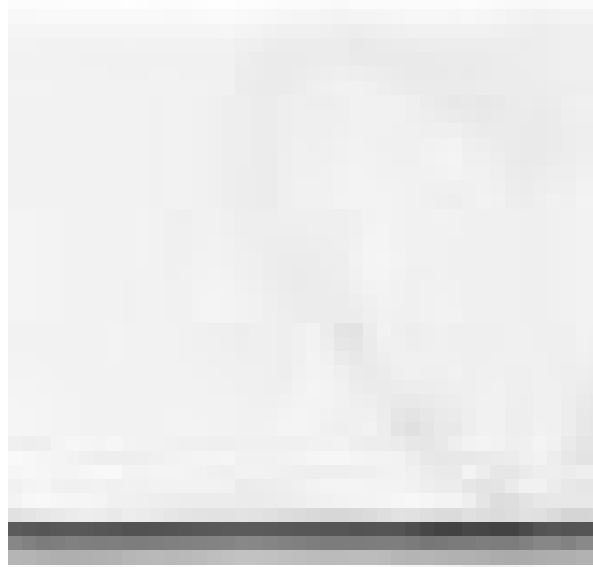

TOUCH CARRARA GLOSS 75 X 300

The Touch series is a collection of glazed ceramic wall tiles with a wavy edge and distinctly hand-made appearance. Available in a range of colours.



NAUTICAL RANGE BASE OPTIONS

CARPET

Luxurious Carpets of great design & texture

A range of durable carpets that retain their look & style much longer than other carpet fibre types.

A wide range of carpets that are resistant or proof to spills, staining, fading, with anti-static and anti-soiling properties. These carpets are easy to clean & maintain and great for any floor areas in your house – bedrooms, living rooms, offices & more.

Colour Disclaimer: Please note colours may vary, it is recommended to go view the colours prior to making a decision.

Belgotex®

INTERNATIONAL CARPET & FLOORING



CARPET

Belgotex Federal

Construction	Tufted Cut Pile Carpet
Yarn	100% Solution Dyed Nylon
Width	3.66m
Total Thickness	13mm
Backing	Action Fleece
Fire Rating	ISO 9239-1
Environmental	Low VOC, solution dyeing uses no water ISO 14001, CRI Green Label Plus Certified.
Usage Rating	Extra Heavy Duty Residential / Medium Duty Commercial
Warranty	10 Year Living Warranty

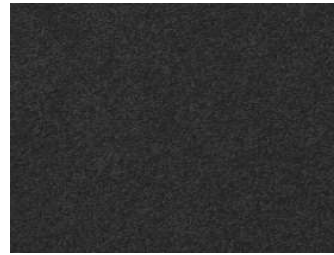

Ash



Bark



Charcoal



Cinder



Fossil



Iron



Nickel



Pearl



Titanium & Zinc

CARPET

Malmo Munich

A fantastic underfoot feel and beautiful shades in this comfortable cut pile carpet, mixing the toughness of Solution Dyed Nylon with the beauty of modern multi-toned yarns.

Fibre: Solution Dyed Nylon

Width: 4m

Weight: 46oz



Allergy Friendly



Easy Maintenance



Exclusive



Fade Resistant



Family Friendly



Hard Wearing



Stain Resistant



Translucent



Polished



Timeless



Luster



Surreal



Damask



Sheer



Aspect



NAUTICAL RANGE BASE OPTIONS

PAINT



Colour Disclaimer: Please note colours may vary, it is recommended to go view the colours prior to making a decision.

Resene
the paint the professionals use

PAINT

Resene



Resene Bianca

Resene Bianca



Resene Alabaster

Resene Alabaster



Resene Quarter Fossil

Resene Quarter Fossil



Resene Half Titania

Resene Half Titania



Resene Half Sea Fog

Resene Half Sea Fog



Resene Black White

Resene Black White

Master Bedroom—indicative style not plan

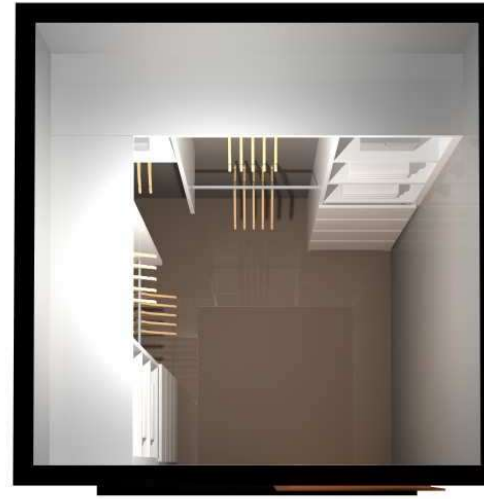

Designer Homeware (NZ) Ltd
0508 2 ORGANISE (67426)
www.designerhomeware.co.nz

EXAMPLE

Material: 25mm White (Pac)

Hardware:
Drawers: Hafele Alto Softclose
Handles: Cutdown Fronts

Accessories:

Sales Rep: Georgia Patten

All dimensions & size designations are subject to site verification and adjustment to fit job conditions. This is an original design and must not be released or copied unless an application fee has been paid or a job order placed.

Designer: Ivy Lee
Print Date: 09/11/21

.....
Date:

Master Bedroom

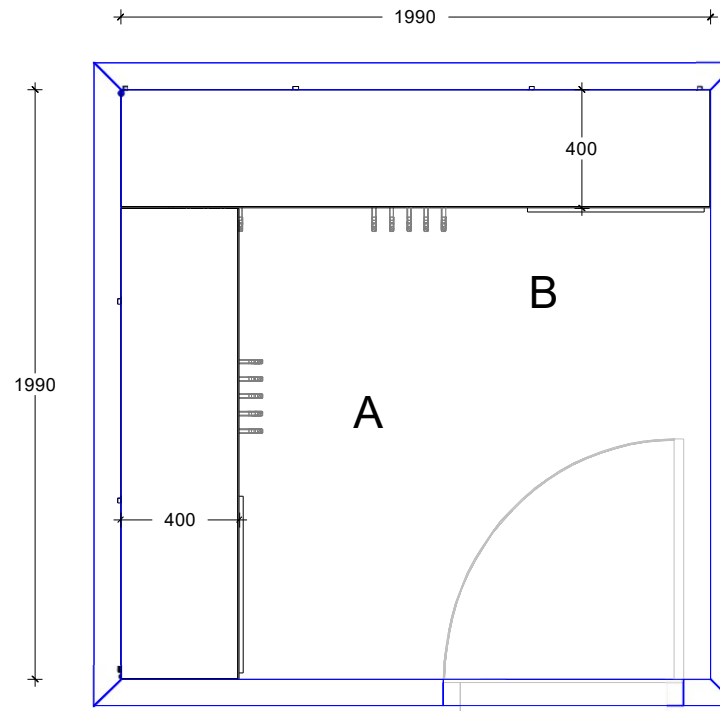
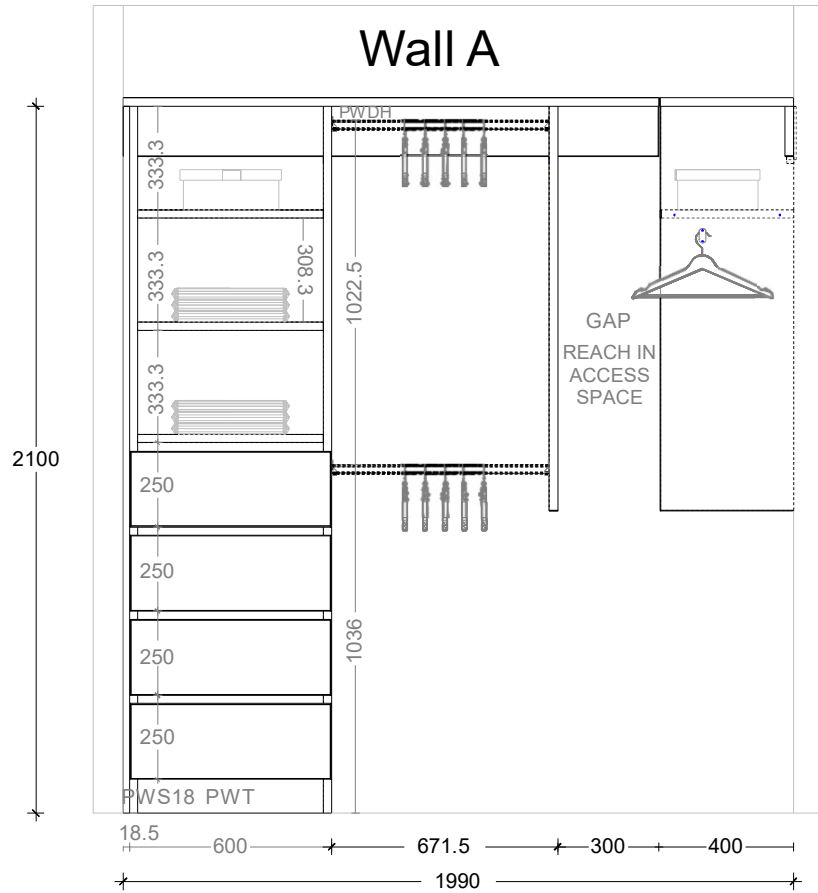

Designer Homeware (NZ) Ltd
0508 2 ORGANISE (67426)
www.designerhomeware.co.nz

EXAMPLE

Material: **25mm White (Pac)**

Hardware:
Drawers: **Hafele Alto**
Softclose Handles:
Cutdown Fronts

Accessories:

Sales Rep: Georgia Patten

All dimensions & size designations are subject to site verification and adjustment to fit job conditions. This is an original design and must not be released or copied unless an application fee has been paid or a job order placed.

Designer: Ivy Lee
Print Date: 09/11/21

Date:

Bedroom 2 Ventilated

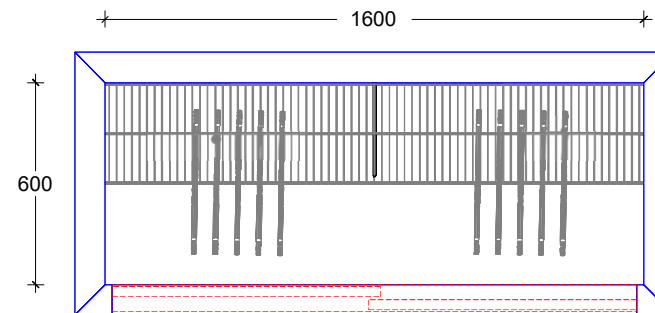
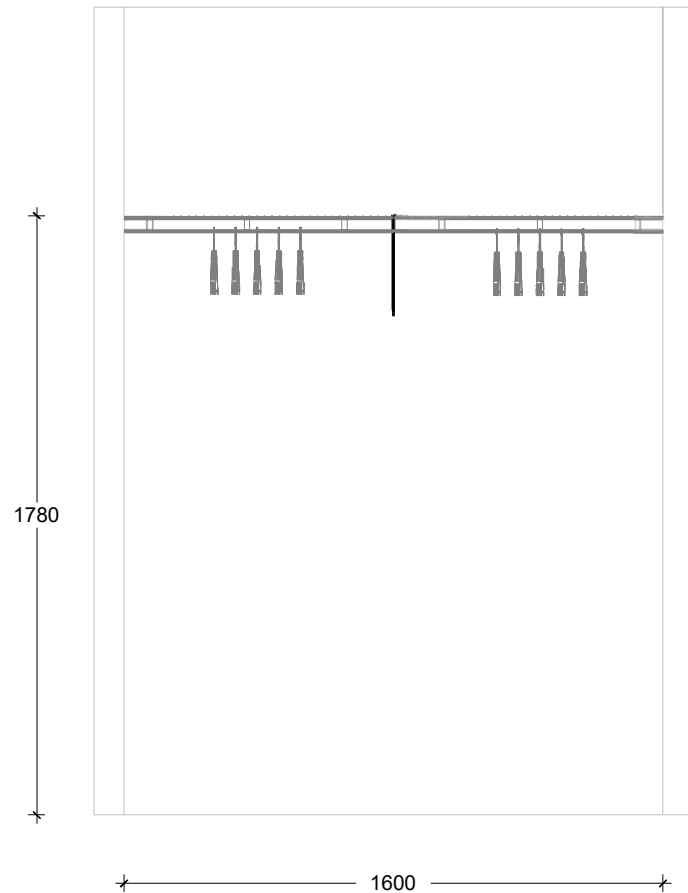

Double Sliders



Designer Homeware (NZ) Ltd
 0508 2 ORGANISE (67426)
www.designerhomeware.co.nz

EXAMPLE

Type: 300 S&R

All dimensions & size designations are subject to site verification and adjustment to fit job conditions. This is an original design and must not be released or copied unless an application fee has been paid or a job order placed.

Designer: Ivy Lee
 Print Date: of 6

Plans and Specifications Approved:

 Date:

Hotwater Cupboard Ventilated

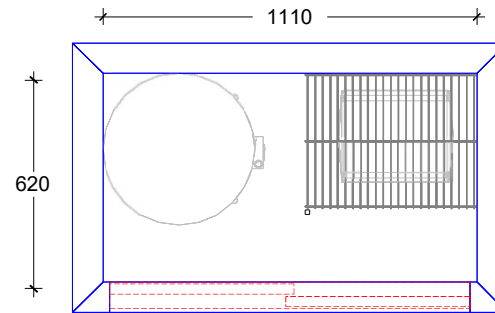
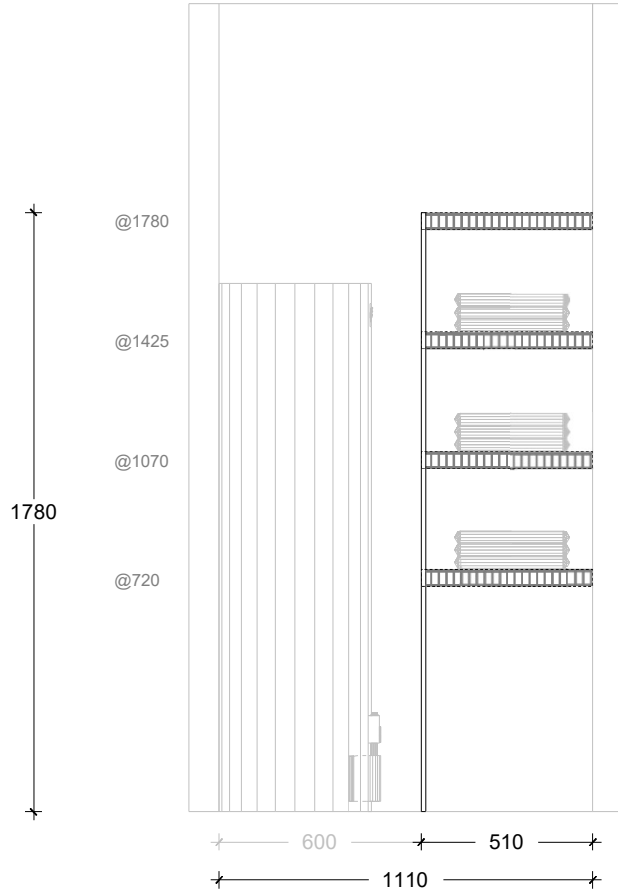

Double Sliders



Designer Homeware (NZ)
 Ltd 0508 2 ORGANISE
 (67426)
www.designerhomeware.co.nz

EXAMPLE

Type: 400 Linen

All dimensions & size designations are subject to site verification and adjustment to fit job conditions. This is an original design and must not be released or copied unless an application fee has been paid or a job order placed.

Designer: Ivy Lee
 Print Date: _____ of 6

Plans and Specifications Approved:

.....

Date:

Excel Life Smart



Smart Home in everyday living

New generation of smart switches and sockets

More ways to control



VOICE



APP

Download on the App Store
GET IT ON Google Play
HOME + CONTROL App



PRESS

Benefits

Make every day life just that little bit easier:



ENHANCE COMFORT & SAFETY



INCREASE ENERGY SAVINGS



REAL-TIME ALERTS



EASY INSTALLATION



GROWING WITH USERS' NEEDS, ADAPTABLE AND OPEN



AFFORDABLE

